

F12-1000

Description:

The F12-1000 is a single primary and dual secondary, split bobbin design which operates with an input of 115V. The output voltage will be either 12.6V with a center-tap under a 1.0A load with the secondaries wired in series, or 6.3V under a 2.0A load with the secondaries wired in parallel. The split bobbin design eliminates the need for costly electrostatic shielding.

Electrical Specifications (@25C)

1. Maximum Power: 12.0VA
2. Primary: 115V
3. Secondary: Series: 12.6V CT@ 1.0A
Parallel: 6.3V @ 2.0A
4. Voltage Regulation: 25% TYP @ full load to no load
5. Temperature Rise: 25C TYP
6. Hipot tested 100% at 2500 VRMS

Construction:

Three flange bobbin construction with primaries and secondaries wound side by side for low capacitive coupling.

Agency File:

UL: File E53148, UL 5085-2 (506), Class B General Purpose Transformer,
cUL: File E53148, UL 5085-2 (506), Class B General Purpose Transformer,
Canadian Use (CSA 22.2, No.66.2-06)

This model is also available in Class 2, UL 5085-3 (1585) version as [F12-1000-C2](#)



Dimensions:

Units in inches.

H	W	L	A	B	C	D	E	F
1.437	1.562	1.875	0.300	0.400	1.410	0.041	0.020	0.234

Weight: 0.70 lbs

Schematic:

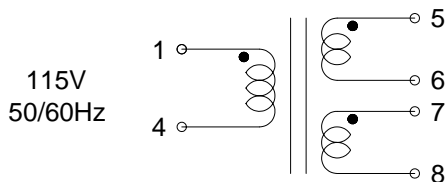

RoHS Compliance:

As of manufacturing date February 2005, all standard products meet the requirements of 2002/95/EC, known as the RoHS initiative.

As of April 7, 2008, UL standards 506 and 1585 will be migrated to UL 5085-2 and 5085-3, respectively.

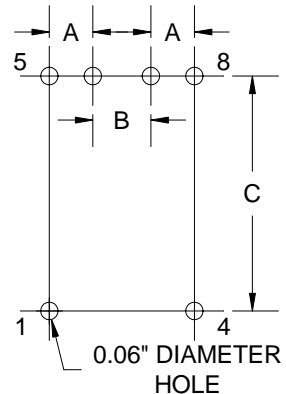
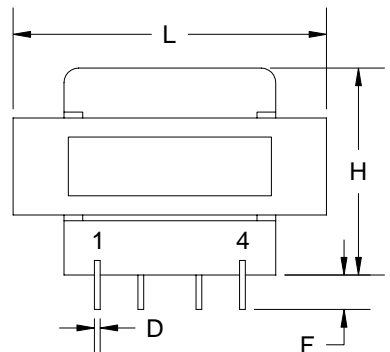
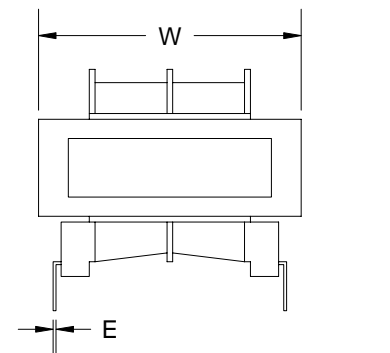
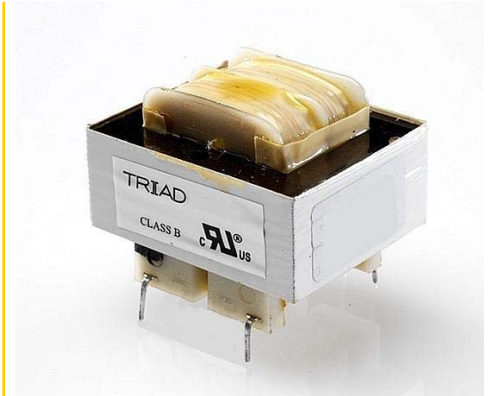

Board Layout

Power Transformers

Class B
UL Recognized



UL File E53148

PC Mount: Split Pack™

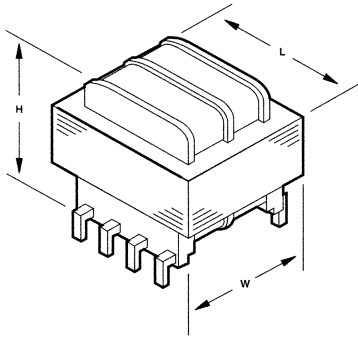

:: Description

The Triad Split Pack split bobbin transformer is an extremely versatile tool for PC board applications. Split Pack transformers are nonconcentrically wound -- with primaries and secondaries side-by-side. Unlike the secondary-on-top-of-primary designs of standard PC board transformers, the split bobbin winding and low capacitive coupling eliminate costly electrostatic shielding. It is offered in a dual secondary configuration with either single or dual primaries.

:: Specifications

Primary: 115 V, 50/60 Hz | **VA Ranges:** 1.1 to 36.0

Secondary: Series - 10 to 120 V; Parallel - 5 to 60 V

:: Split Pack

Section	Single Primary 6 Pin	Dual Primary 8 Pin	VA	Secondary		Dimensions							Wt. Lbs.
				Series	Parallel	H	W	L	ML	A	B	C	
A	F10-110	FS10-110	1.1	10.0V CT @ 0.11A	5.0V @ 0.22A	15/16	17/8	17/8	•	0.250	0.250	1.20	0.17
	F12-090	FS12-090		12.6V CT @ 0.09A	6.3V @ 0.18A								
	F16-070	FS16-070		16.0V CT @ 0.07A	8.0V @ 0.14A								
	F20-055	FS20-055		20.0V CT @ 0.055A	10.0V @ 0.11A								
	F24-045	FS24-045		24.0V CT @ 0.045A	12.0V @ 0.09A								
	F28-040	FS28-040		28.0V CT @ 0.040A	14.0V @ 0.08A								
	F36-030	FS36-030		36.0V CT @ 0.03A	18.0V @ 0.06A								
	F48-023	FS48-023		48.0V CT @ 0.023A	24.0V @ 0.046A								
	F56-020	FS56-020		56.0V CT @ 0.02A	28.0V @ 0.04A								
	F120-010	FS120-01		120.0V CT @ 0.01A	60.0V @ 0.02A								
	B	F10-250		FS10-250	2.5								
F12-200		FS12-200	12.6V CT @ 0.2A	6.3V @ 0.4A									
F16-150		FS16-150	16.0V CT @ 0.15A	8.0V @ 0.3A									
F20-120		FS20-120	20.0V CT @ 0.12A	10.0V @ 0.24A									
F24-100		FS24-100	24.0V CT @ 0.1A	12.0V @ 0.2A									
F28-85		FS28-85	28.0V CT @ 0.085A	14.0V @ 0.17A									
F36-65		FS36-65	36.0V CT @ 0.065A	18.0V @ 0.13A									
F48-050		FS48-050	48.0V CT @ 0.05A	24.0V @ 0.1A									
F56-045		FS56-045	56.0V CT @ 0.045A	28.0V @ 0.09A									
F120-020		FS120-02	120.0V CT @ 0.02A	60.0V @ 0.04A									
C		F10-600	FS10-600	6.0		10.0V CT @ 0.6A	5.0V @ 1.2A	17/16	17/16	17/8	17/16	0.250	0.350
	F12-500	FS12-500	12.6V CT @ 0.5A		6.3V @ 1.0A								
	F16-400	FS16-400	16.0V CT @ 0.4A		8.0V @ 0.8A								
	F20-300	FS20-300	20.0V CT @ 0.3A		10.0V @ 0.6A								
	F24-250	FS24-250	24.0V CT @ 0.25A		12.0V @ 0.5A								
	F28-200	FS28-200	28.0V CT @ 0.2A		14.0V @ 0.4A								
	F36-170	FS36-170	36.0V CT @ 0.17A		18.0V @ 0.34A								
	F48-125	FS48-125	48.0V CT @ 0.125A		24.0V @ 0.25A								
	F56-110	FS56-110	56.0V CT @ 0.11A		28.0V @ 0.22A								
	F120-050	FS120-05	120.0V CT @ 0.05A		60.0V @ 0.1A								
	D	F10-1200	FS10-1200		12.0	10.0V CT @ 1.2A	5.0V @ 2.4A						
F12-1000		FS12-1000	12.6V CT @ 1.0A	6.3V @ 2.0A									
F16-800		FS16-800	16.0V CT @ 0.8A	8.0V @ 1.6A									
F20-600		FS20-600	20.0V CT @ 0.6A	10.0V @ 1.2A									
F24-500		FS24-500	24.0V CT @ 0.5A	12.0V @ 1.0A									
F28-420		FS28-420	28.0V CT @ 0.42A	14.0V @ 0.84A									
F36-350		FS36-350	36.0V CT @ 0.35A	18.0V @ 0.7A									
F48-250		FS48-250	48.0V CT @ 0.25A	24.0V @ 0.5A									
F56-220		FS56-220	56.0V CT @ 0.22A	28.0V @ 0.44A									
F120-100		FS120-100	120.0V CT @ 0.1A	60.0V @ 0.2A									
E		F10-2000	FS10-2000	20.0		10.0V CT @ 2.0A	5.0V @ 4.0A	17/16	17/8	27/8	17/2	0.30	0.40
	F12-1600	FS12-1600	12.6V CT @ 1.6A		6.3V @ 3.2A								
	F16-1250	FS16-1250	16.0V CT @ 1.25A		8.0V @ 2.5A								
	F20-1000	FS20-1000	20.0V CT @ 1.0A		10.0V @ 2.0A								
	F24-800	FS24-800	24.0V CT @ 0.8A		12.0V @ 1.6A								
	F28-700	FS28-700	28.0V CT @ 0.7A		14.0V @ 1.4A								
	F36-550	FS36-550	36.0V CT @ 0.55A		18.0V @ 1.1A								
	F48-400	FS48-400	48.0V CT @ 0.4A		24.0V @ 0.8A								
	F56-350	FS56-350	56.0V CT @ 0.35A		28.0V @ 0.7A								
	F120-160	FS120-160	120.0V CT @ 0.16A		60.0V @ 0.32A								

CT = Center Tap

Power Transformers

PC Mount: Split Pack™

Section	Single Primary 6 Pin	Dual Primary 8 Pin	VA	Secondary		Dimensions						Wt. Lbs.	
				Series	Parallel	H	W	L	ML	A	B		C
A	F10-3600	FS10-3600	36.0	10.0V CT @ 3.6A	5.0V @ 7.2A	1 ¹ / ₁₆	2 ³ / ₁₆	2 ³ / ₁₆	*	0.40	0.40	1.850	1.1
	F12-2850	FS12-2850		12.6V CT @ 2.85A	6.3V @ 5.7A								
	F16-2250	FS16-2250		16.0V CT @ 2.25A	8.0V @ 4.5A								
	F20-1800	FS20-1800		20.0V CT @ 1.8A	10.0V @ 3.6A								
	F24-1500	FS24-1500		24.0V CT @ 1.5A	12.0V @ 3.0A								
	F28-1300	FS28-1300		28.0V CT @ 1.3A	14.0V @ 2.6A								
	F36-1000	FS36-1000		36.0V CT @ 1.0A	18.0V @ 2.0A								
	F48-750	FS48-750		48.0V CT @ 0.75A	24.0V @ 1.5A								
	F56-650	FS56-650		56.0V CT @ 0.65A	28.0V @ 1.3A								
	F120-300	FS120-300		120.0V CT @ 0.3A	60.0V @ 0.6A								

* 36 VA size has 4 mtg. holes on 2³/₁₆ x 1¹/₄ centers. CT = Center Tap

:: Outline Dimensions

Technical Notes

- Hi-pot tested at 2,500 VRMS.
- PC terminal pin spacing for accurate placement.
- 115 V connect primary in parallel.
230 V connect primary in series.

4. **Series Connections:** Primary - Input 1 & 4
Connect 2 & 3
Secondary - Input 5 & 8
Connect 6 & 7

5. **Parallel Connections:** Primary - Input 1 & 2
Connect 1 & 3, 2 & 4
Secondary - Input 5 & 8
Connect 5 & 7, 6 & 8

6. For single primary, omit pins 2 and 3.

